

# W916



## INFORMAZIONI TECNICHE - TECHNICAL INFORMATION

Portata (L/min)	Flow (L/min)	18
Portata (US Gpm)	Flow (US Gpm)	4,75
Regime di rotazione (rpm)	Rotation regime (rpm)	1750
Pressione (MPa)	Pressure (MPa)	16
Pressione (bar)	Pressure (bar)	160
Pressione (psi)	Pressure (psi)	2320
Potenza (hp)	Power (hp)	7,5
Potenza (kW)	Power (kW)	5,51
Dimensioni d'ingombro L x l x h (mm)	Overall dimensions L x l x h (mm)	327x236x180
Peso (kg)	Weight (kg)	14,5

# W916

## VERSIONI - VERSIONS

Albero maschio con linguetta - Male shaft (key)	Pag.	3
Albero maschio con linguetta - vers. ATEX - Male shaft (key) - vers. ATEX	Pag.	6

# Albero maschio con linguetta - Male shaft (key)

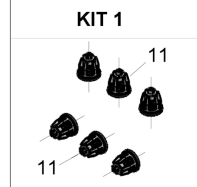
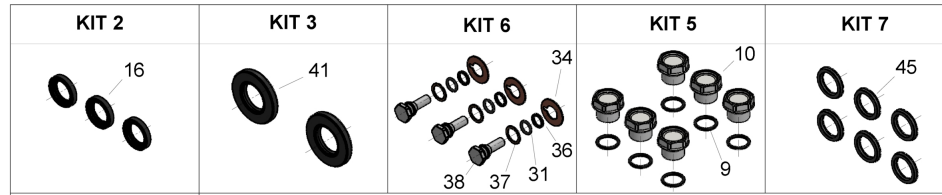

Lubrificare con grasso di vasellina cod. 12.0021.00  
**\*\***  
 Lubricate with vaseline grease cod. 12.0021.00

Fissare con Loctite 542 colore ROSSO cod. 12.0062.00  
 \*  
 Fix with red Loctite 542 cod. 12.0062.00

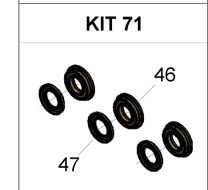
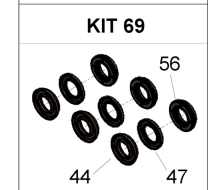
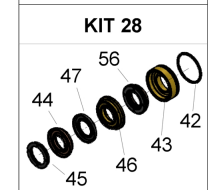
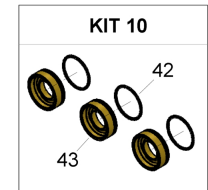
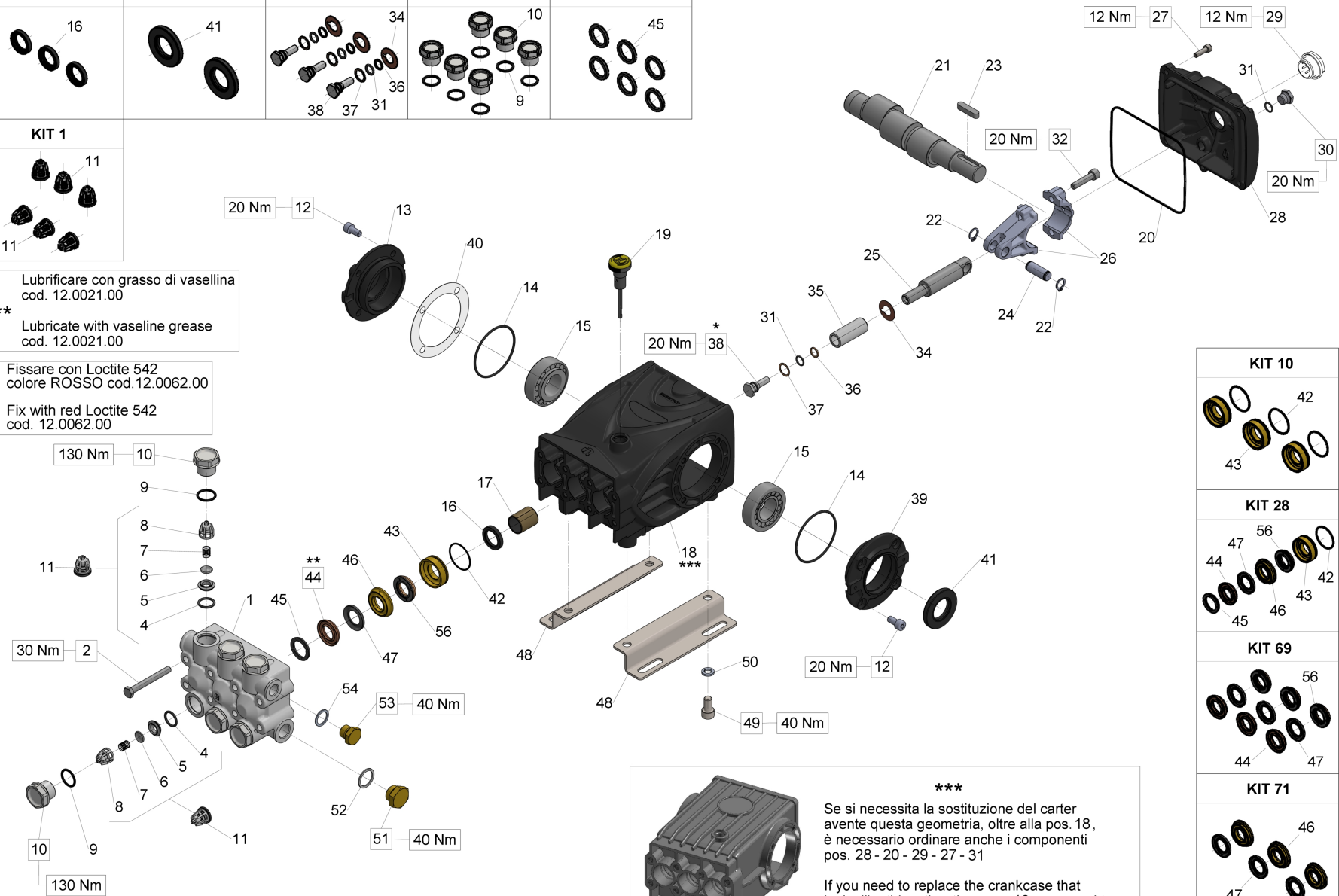

**\*\*\***  
 Se si necessita la sostituzione del carter avente questa geometria, oltre alla pos. 18, è necessario ordinare anche i componenti pos. 28 - 20 - 29 - 27 - 31  
 If you need to replace the crankcase that looks like this, other than pos. 18, you need to order also components pos. 28 - 20 - 29 - 27 - 31

## Albero maschio con linguetta - Male shaft (key)

Ref.	Codice - Part n°	Qtà - Qty	Descrizione	Description
1	47120241	1	TESTATA POMPA D.20-22-24 NK.	MANIFOLD
2	99320600	8	VITE TE M8X70 UNI5737 10.9 ZB	HEX-HEAD SCREW M08X70 UNI5737 10.9 Fe/Zn5c1A+De
4	90384100	6	OR D.17,13X2,62 (3068)	O-RING 17,12X2,62 (3068)
5	36200366	6	SEDE VALVOLA ASP. E MANDATA	VALVE SEAT
6	36200176	6	VALVOLA SFERICA	VALVE PLATE
7	94737600	6	MOLLA DM 9,4X14,8 INOX	SPRING D. 9,4X14,8
8	36200251	6	GUIDA VALVOLA ASP. MANDATA	VALVE CAGE
9	90384700	6	OR D.20,24X2,62 (3081)	O-RING 20,29X2,62(3081)
10	98222200	6	TAPPO M24x2x16.5 NICKEL	VALVE PLUG M24X2X16 NICKEL PL.
11	36703201	6	GR. VALVOLA ASP. MAND.	VALVE ASSY.
12	99303900	8	VITE TCEI M8X16 ZINC. UNI5931	SCREW M 8x16 UNI 5931
13	47151122	1	COPERCHIO LAT. CHIUSO S.47-66	CLOSED SIDE COVER (47-66)
14	90391300	2	OR D.67,95X2,62 (3268)	O-RING 67,95X2,62 (3268)
15	91837500	2	CUSC. RULLI CON. 30X62X21.25-32206	TAPER BEARING
16	90162500	3	ANELLO RADIALE D.22X32X5	OIL SEAL 22x32x5
17	90912600	3	BOCCOLA D.22X25X30	BUSHING 22X25X30
18	47010822	1	CARTER POMPA	CRANKCASE
19	98210600	1	ASTA LIV. OLIO G3/8X64 COMPL.	OIL DIP-STICK G3/8X80
20	90392200	1	OR D.133,02X2,62 (3525)	O-RING D.133.02X 2,62(3525)
21	47021835	1	ALBERO ECC.C.12 SPDF 24x40 (marc. 6)	CRANKSHAFT C.12 S.p.f. U.S.
22	90055700	6	ANELLO SEEGER ALBERI UNI 7435-12	CIRCLIP D.12 UNI 7435
23	91489200	1	LINGUETTA 8X7X35	KEY 8(h9)X7X35 UNI 6604/A
24	97738000	3	SPINOTTO D.13X35.5	CONNECTING-ROD PIN D.13X35,5
25	47050466	3	GUIDA PISTONE - INOX	PISTON GUIDE - S.S.
26	47030001	3	BIELLA COMPLETA	CONNECTING ROD
27	99188400	5	VITE TCEI M6X20 8.8 ZINCATA	SCREW M 6x20 UNI 5931
28	47160622	1	COPERCHIO POSTERIORE	CRANKCASE COVER
29	47221301	1	GRUPPO SPIA LIVELLO OLIO G3/4	OIL SIGHT GLASS ASSY G3/4
30	98204250	1	TAPPO G1/4X9 TE17 ZINC.	PLUG G1/4"x12
31	90358500	4	OR D.10,82X1,78 (2043)	O-RING 10,82X1,78 (2043)
32	99309900	6	VITE TCEI M8X35	SCREW M 8x35 UNI 5931
34	96728600	3	ROSETTA D.14X28X0,5 CU	WASHER 14X28X0,5
35	47040409	3	PISTONE D.20x50	PISTON D. 20x50
36	90506700	3	ANELLO ANTIES.D.11X14X1.5	ANTI-EXTRUSION RING
37	96728000	3	ROSETTA D.14X18.5X0.5	WASHER 14X18,5X0,5
38	47219566	3	VITE FISSAGGIO PISTONE	PISTON SCREW

## Albero maschio con linguetta - Male shaft (key)

Ref.	Codice - Part n°	Qtà - Qty	Descrizione	Description
39	47151022	1	COPERCHIO LAT. APERTO S.47-66	OPEN SIDE COVER (47-66)
40	97567800	1	SPESSORE D. 74,5X104X0,1	SHIM D.74,5X104X0,1
40	97568000	1	SPESSORE D.74,5X104X0,3	SHIM D.74.5X104X0.3
41	90164800	1	ANELLO RAD. D.30X55X7	OIL SEAL 30x55x7
42	90361600	3	OR D.34,65X1,78 (2137)	O-RING 34,65X1,78 (2137)
43	47080570	3	ANELLO DI FONDO D.20	PACKING RETAINER D. 20x35
44	90270500	3	ANELLO TEN.D.20X35X7,5/4.5H.P.	PACKING 20x35x7,5
45	47100051	3	ANELLO DI TESTA D.20	HEAD RING D. 20
46	47216970	3	ANELLO INTERMEDIO D.20	INTERM.RING D. 20 (SPEC.)
47	90270400	3	ANELLO "RESTOP" 20X35X5,5/2	RESTOP RING D. 20 TYPE 6/1
48	47200074	2	PIEDINO FISSAGGIO POMPA	PUMP FOOT
49	99364400	4	VITE TCEI M10X18 8.8 ZINCATA UNI5931	SCREW M 10x18-5931
50	96710600	4	RONDELLA D.10 UNI1751	WASHER 10,2
51	98217600	1	TAPPO G 1/2X10	PLUG G1/2X10
52	96751400	1	ROSETTA D.21,5X27X1,5	WASHER 21,5X27X1,5
53	98210000	1	TAPPO G 3/8X13	PLUG G3/8X13
54	96738000	1	ROSETTA D.17,5X23X1,5 AL.	WASHER 17,5X23X1,5
56	90271000	3	ANELLO TEN.ALT.20X35X8,7 L.P	PACKING D.20X35X9 L.P.
KIT1	34000101	1	KIT 1	KIT 1 INTAKE/DELIVERY VALVE
KIT2	34000201	1	KIT 2	KIT 2 OIL SEAL D. 22X32X5,5
KIT3	34000301	1	KIT 3	KIT 3 OIL SEAL D.30X55X7
KIT5	34000501	1	KIT 5 TAPPI VALV. ASP. MAND.	KIT 5 INTAKE/DEL.VALVE CAPS
KIT6	34000601	1	KIT 6	KIT 6 PISTON BOLT
KIT7	34000701	1	KIT 7	KIT 7 HEAD RING D.20
KIT10	34001001	1	KIT 10	KIT 10 PACKING RETAINER D.20
KIT28	34002801	1	KIT 28	KIT 28 COMPL.SEAL FOR PIST.D20
KIT69	34006901	1	KIT 69	KIT 69 PACKING D.20 W/RESTOP
KIT71	34007101	1	KIT 71	KIT 71 INTERMEDIATE RING D.20

# Albero maschio con linguetta - vers. ATEX - Male shaft (key) - vers. ATEX

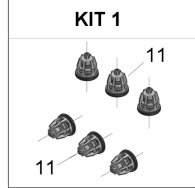
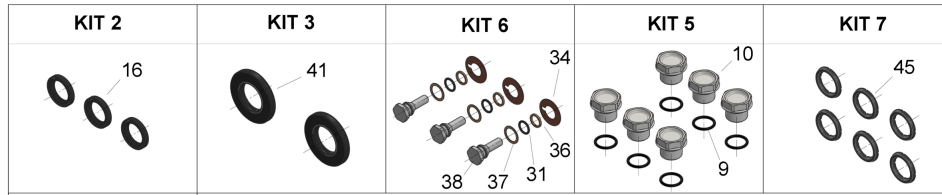

Fissare con Loctite 542 colore ROSSO cod. 12.0062.00  
\* Fix with red Loctite 542 cod. 12.0062.00

Lubrificare con grasso di vasellina cod. 12.0021.00  
\*\* Lubricate with vaseline grease cod. 12.0021.00

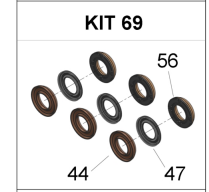
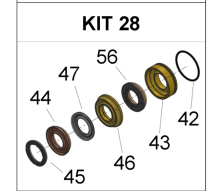
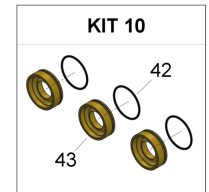
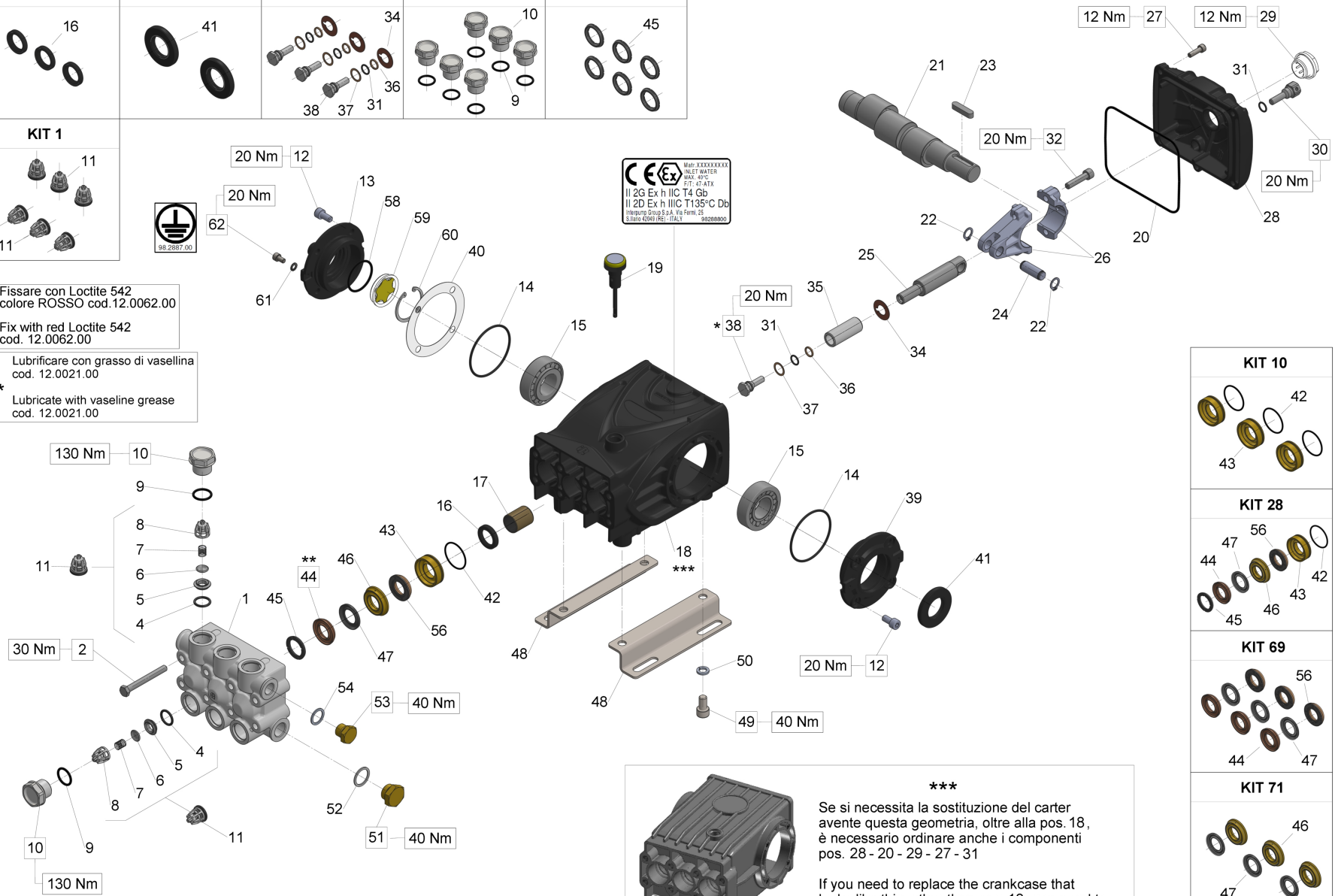
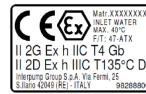

**\*\*\***  
Se si necessita la sostituzione del carter avente questa geometria, oltre alla pos. 18, è necessario ordinare anche i componenti pos. 28 - 20 - 29 - 27 - 31  
If you need to replace the crankcase that looks like this, other than pos. 18, you need to order also components pos. 28 - 20 - 29 - 27 - 31

**Albero maschio con linguetta - vers. ATEX - Male shaft (key) - vers. ATEX**

Ref.	Codice - Part n°	Qtà - Qty	Descrizione	Description
1	47120241	1	TESTATA POMPA D.20-22-24 NK.	MANIFOLD
2	99320600	8	VITE TE M8X70 UNI5737 10.9 ZB	HEX-HEAD SCREW M08X70 UNI5737 10.9 Fe/Zn5c1A+De
4	90384100	6	OR D.17,13X2,62 (3068)	O-RING 17,12X2,62 (3068)
5	36200366	6	SEDE VALVOLA ASP. E MANDATA	VALVE SEAT
6	36200176	6	VALVOLA SFERICA	VALVE PLATE
7	94737600	6	MOLLA DM 9,4X14,8 INOX	SPRING D. 9,4X14,8
8	36200251	6	GUIDA VALVOLA ASP. MANDATA	VALVE CAGE
9	90384700	6	OR D.20,24X2,62 (3081)	O-RING 20,29X2,62(3081)
10	98222200	6	TAPPO M24x2x16.5 NICKEL	VALVE PLUG M24X2X16 NICKEL PL.
11	36703201	6	GR. VALVOLA ASP. MAND.	VALVE ASSY.
12	99303900	8	VITE TCEI M8X16 ZINC. UNI5931	SCREW M 8x16 UNI 5931
13	47151322	1	COPERCHIO LAT. SPIA S.47-66	SIDE CRANKCASE COVER (ATEX)
14	90391300	2	OR D.67,95X2,62 (3268)	O-RING 67,95X2,62 (3268)
15	91837500	2	CUSC. RULLI CON. 30X62X21.25-32206	TAPER BEARING
16	90162500	3	ANELLO RADIALE D.22X32X5	OIL SEAL 22x32x5
17	90912600	3	BOCCOLA D.22X25X30	BUSHING 22X25X30
18	47010822	1	CARTER POMPA	CRANKCASE
19	98210700	1	TAPPO CON ASTA G3/8X64 D.4+FILTRO	OIL DIPSTICK G3/8X64 D4+FILTER ATEX
20	90392200	1	OR D.133,02X2,62 (3525)	O-RING D.133.02X 2,62(3525)
21	47021835	1	ALBERO ECC.C.12 SPDF 24x40 (marc. 6)	CRANKSHAFT C.12 S.p.f. U.S.
22	90055700	6	ANELLO SEEGER ALBERI UNI 7435-12	CIRCLIP D.12 UNI 7435
23	91489200	1	LINGUETTA 8X7X35	KEY 8(h9)X7X35 UNI 6604/A
24	97738000	3	SPINOTTO D.13X35.5	CONNECTING-ROD PIN D.13X35,5
25	47050466	3	GUIDA PISTONE - INOX	PISTON GUIDE - S.S.
26	47030001	3	BIELLA COMPLETA	CONNECTING ROD
27	99188400	5	VITE TCEI M6X20 8.8 ZINCATA	SCREW M 6x20 UNI 5931
28	47160622	1	COPERCHIO POSTERIORE	CRANKCASE COVER
29	47221301	1	GRUPPO SPIA LIVELLO OLIO G3/4	OIL SIGHT GLASS ASSY G3/4
30	98203600	1	TAPPO G1/4X8 PER SONDA D.6 SS	PLUG G1/4x8 FOR PROBE D.6 S.S.
31	90358500	4	OR D.10,82X1,78 (2043)	O-RING 10,82X1,78 (2043)
32	99309900	6	VITE TCEI M8X35	SCREW M 8x35 UNI 5931
34	96728600	3	ROSETTA D.14X28X0,5 CU	WASHER 14X28X0,5
35	47040409	3	PISTONE D.20x50	PISTON D. 20x50
36	90506700	3	ANELLO ANTIES.D.11X14X1.5	ANTI-EXTRUSION RING
37	96728000	3	ROSETTA D.14X18.5X0.5	WASHER 14X18,5X0,5
38	47219566	3	VITE FISSAGGIO PISTONE	PISTON SCREW

**Albero maschio con linguetta - vers. ATEX - Male shaft (key) - vers. ATEX**

Ref.	Codice - Part n°	Qtà - Qty	Descrizione	Description
39	47151022	1	COPERCHIO LAT. APERTO S.47-66	OPEN SIDE COVER (47-66)
40	97567800	1	SPESSORE D. 74,5X104X0,1	SHIM D.74,5X104X0,1
40	97568000	1	SPESSORE D.74,5X104X0,3	SHIM D.74.5X104X0.3
41	90164800	1	ANELLO RAD. D.30X55X7	OIL SEAL 30x55x7
42	90361600	3	OR D.34,65X1,78 (2137)	O-RING 34,65X1,78 (2137)
43	47080570	3	ANELLO DI FONDO D.20	PACKING RETAINER D. 20x35
44	90270500	3	ANELLO TEN.D.20X35X7,5/4.5H.P.	PACKING 20x35x7,5
45	47100051	3	ANELLO DI TESTA D.20	HEAD RING D. 20
46	47216970	3	ANELLO INTERMEDIO D.20	INTERM.RING D. 20 (SPEC.)
47	90270400	3	ANELLO "RESTOP" 20X35X5,5/2	RESTOP RING D. 20 TYPE 6/1
48	47200074	2	PIEDINO FISSAGGIO POMPA	PUMP FOOT
49	99364400	4	VITE TCEI M10X18 8.8 ZINCATA UNI5931	SCREW M 10x18-5931
50	96710600	4	RONDELLA D.10 UNI1751	WASHER 10,2
51	98217600	1	TAPPO G 1/2X10	PLUG G1/2X10
52	96751400	1	ROSETTA D.21,5X27X1,5	WASHER 21,5X27X1,5
53	98210000	1	TAPPO G 3/8X13	PLUG G3/8X13
54	96738000	1	ROSETTA D.17,5X23X1,5 AL.	WASHER 17,5X23X1,5
56	90271000	3	ANELLO TEN.ALT.20X35X8,7 L.P	PACKING D.20X35X9 L.P.
58	90387700	1	OR D.39,34X2,62 (3156)	O-RING 39,34X2,62 (3156)
59	70211801	1	SPIA LIVELLO OLIO	OIL SIGHT GLASS
60	90075500	1	ANELLO SEEGER PER FORO D.45	STOP RING J45 UNI7437
61	96693950	1	ROSETTA D.6.4X11X0.7 DIN6798 INOX	WASHER 6.4x11.0x0.7 D6798A INOX
62	99180900	1	VITE TCEI M06X10 UNI5931 INOX	SCREW M06X10 5931 A2-70
KIT1	34000101	1	KIT 1	KIT 1 INTAKE/DELIVERY VALVE
KIT2	34000201	1	KIT 2	KIT 2 OIL SEAL D. 22X32X5,5
KIT3	34000301	1	KIT 3	KIT 3 OIL SEAL D.30X55X7
KIT5	34000501	1	KIT 5 TAPPI VALV. ASP. MAND.	KIT 5 INTAKE/DEL.VALVE CAPS
KIT6	34000601	1	KIT 6	KIT 6 PISTON BOLT
KIT7	34000701	1	KIT 7	KIT 7 HEAD RING D.20
KIT10	34001001	1	KIT 10	KIT 10 PACKING RETAINER D.20
KIT28	34002801	1	KIT 28	KIT 28 COMPL.SEAL FOR PIST.D20
KIT69	34006901	1	KIT 69	KIT 69 PACKING D.20 W/RESTOP
KIT71	34007101	1	KIT 71	KIT 71 INTERMEDIATE RING D.20