

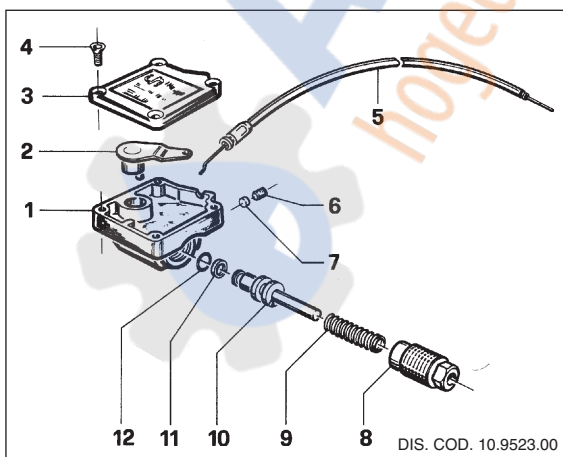

ORD. CODE: Z SPEED

TECHNICAL CHARACTERISTICS - CARATTERISTICHE TECNICHE

MIN. PRESSURE PRESSIONE MIN.			MAX. PRESSURE PRESSIONE MAX.			MAX. TEMPERATURE TEMPERATURA MAX.		STROKE CORSA		CABLE LENGTH LUNGHEZZA CAVO		WEIGHT PESO		INLET ENTRATA
bar	MPa	p.s.i.	bar	MPa	p.s.i.	°C	°F	mm	in	mm	in	Kg.	lbs.	
50	5	725	200	20	3000	75	167	0-30	0-1.18	1000	39,37	0,43	0,95	G 3/8 M



PARTS LIST

POS.	CODE CODICE	DESCRIPTION DESCRIZIONE	N. PCS.
1	10.0440.41	Corpo comando acceleratore	1
2	10.0445.02	Leva	1
3	10.0441.51	Coperchio comando acceleratore	1
4	99.1272.00	Vite M 4x12 UNI 7688	4
5	10.0446.01	Cavo acceleratore	1
6	99.1507.00	Vite M 5x6 UNI 5923	1
7	10.0192.62	Pastiglia freno filetti	1
8	10.0447.70	Vite registro	1
9	94.7346.00	Molla Ø 7,7x37 inox	1
10	10.0442.70	Pistoncino comando	1
11	90.5025.00	Anello per OR Ø 7x10x1,5	1
12	90.3576.00	OR Ø 6,75x1,78 spec.	1

INSTRUCTIONS FOR ASSEMBLY ISTRUZIONI PER IL MONTAGGIO

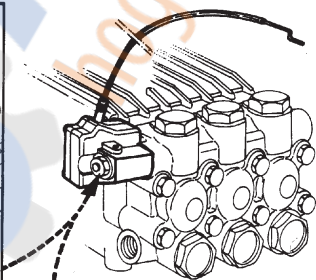
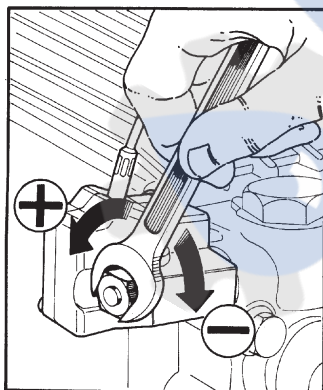
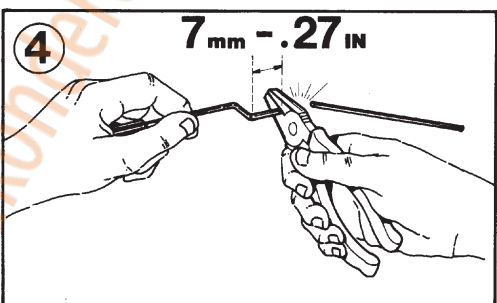
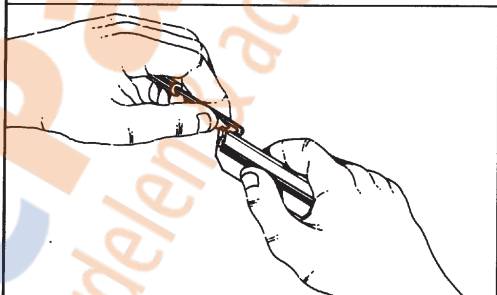
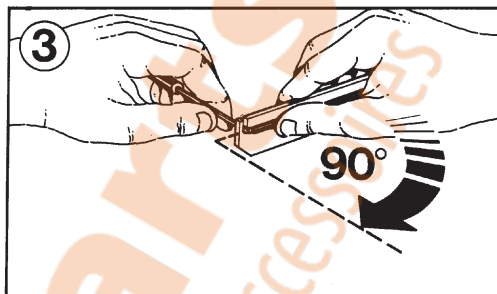
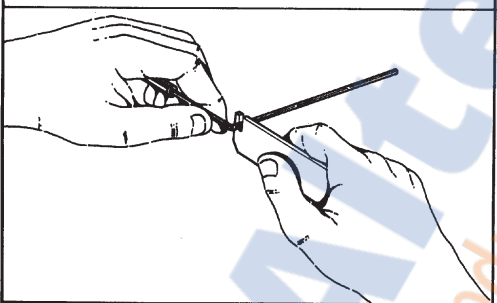
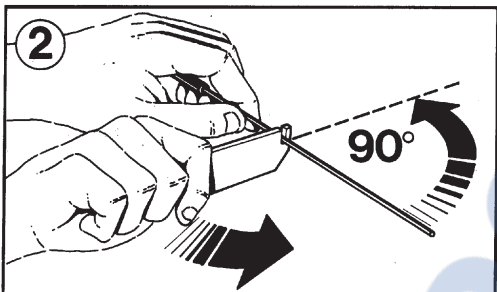
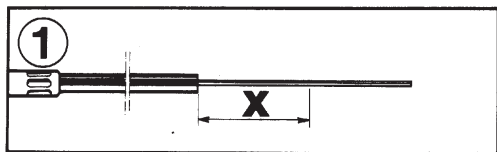

- ADJUSTING SCREW
- VIS DE REGLAGE
- VERSTELLSCHRAUBE
- TORNILLO DE REGULACIÓN
- VITE DI REGISTRO

- THE STROKE CAN BE ADJUSTED FROM 0 TO 30 mm. (0-1.18 in)
- LA COURSE DE TRAVAIL PEUT ÊTRE REGLÉE DE 0 À 30 mm.
- DER NUTZHUBKANN VON 0 BIS 30 mm. VERSTELLT WERDEN.
- LA CARRERA DE TRABAJO PUEDE SER REGULADA DE 0 A 30 mm.
- LA CORSA DI LAVORO PUÒ ESSERE REGOLATA DA 0 A 30 mm.